

COMBINATION PAPER/WASTE WP530



298 x 898 x 120 mm

250 paper towels, 11 l waste bin

- Combination consisting of a paper towel dispenser and a waste bin in robust, germ-reducing and easy-care stainless steel (AISI 304).
- All-stainless steel housing; all corners fully welded, visible surfaces satin finished and brushed. Further available surfaces: see below.
- Paper towel dispenser with deep-drawn paper removal opening for easy paper removal.
- Designed for approx. 250 standard paper towels in zigzag fold. Paper size (folded): 240-250 mm x 100-115 mm.
- Inspection slot to indicate fill level.
- Accessible for refilling through lockable front flap with fall protection.
- Waste bin equipped with removable mesh basket. Capacity approx. 11 l. Accessible through lockable door with self-closing, flame-retardant disposal flap.
- Keyed alike cylinder locks in corrosion-resistant zinc die-casting.
- Wear parts and front panels can be replaced as modules.
- Installation dimensions: 300 x 900 x 110 mm
- Mounting: With four screws in wall opening through fixing holes in the side walls.
- Delivery includes fixing material and one pack of paper towels.
- Weight, including single package: 9.3 kg



Suggested text for specifications:

Combination consisting of a paper towel dispenser and a waste bin in stainless steel (AISI 304) for flush mounting. All-stainless steel housing; all corners fully welded, visible surfaces satin finished and brushed. Paper towel dispenser with deep-drawn paper removal opening, filling quantity approx. 250 paper towels. Inspection slot to indicate fill level. Accessible for refilling through lockable front flap with fall protection. Waste bin equipped with removable mesh basket. Capacity approx. 11 l. Accessible through lockable door with self-closing, flame-retardant disposal flap. Keyed alike cylinder locks in corrosion-resistant zinc die-casting. Delivery includes fixing material and one pack of paper towels.

Dimensions: 298 x 898 x 120 mm

Article No. WP530

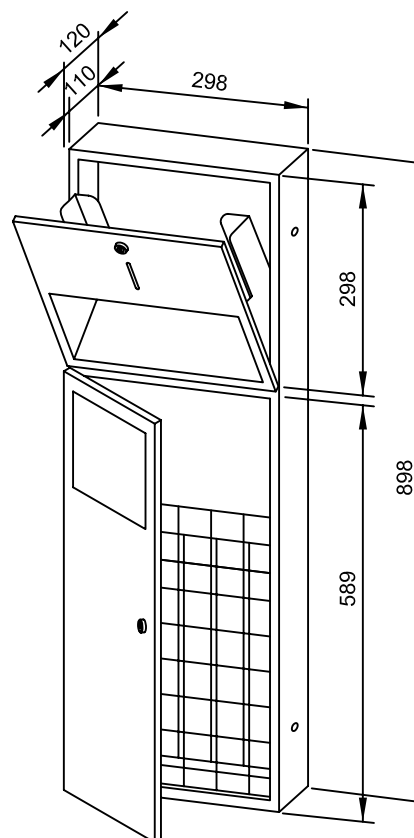

Available surfaces	ID No.
satin finished (standard)	722 982
highly polished	731 982
(coloured) plastic powder-coating	728 092

Ernst Wagner GmbH & Co. KG

Ernst-Abbe-Straße 21 · D-72770 Reutlingen · Tel.: +49712151539-0 · Fax: -20
info@wagner-ewar.de · www.wagner-ewar.de

WAGNER
E W A R